



000 00 000 160000 Trionic LED 0000 000 000 000000.

0 0000 00(00 00 0)0 000 000 00000 00000 000 00000(00 000 0)0 0 00 000 00000 0000 00 000000.

00 0000 A0 Walker0 00 00 00(00 20 + 00 20)0 000000. B0 Veloped0 00 00 00(00 10 + 00 00 10 + 00 10)0 000000.

0000 00 00

00 00 0000



A1. 000 0000 00 00000 00000 00 00 00 00 00 0 00000 00 0 00 00000.



A2. LED 0000 0000 5mm 00 0000 00000 0 00 0000 0000.

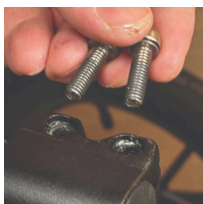

A3. 00 000000 00 0 00 000000.

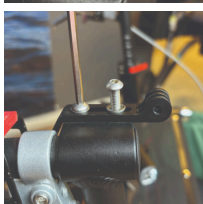

A4. 00 0000 00 00 0000 00, 00 00 00 00 0000 00 00 00000 0000. 0000 00 00 0 00 0000 0000 0 0000.



A5. 5mm 00 0000 0 00 0000 000000. 00: 0000 0 0000 00 00, 00000 0000 00000 0000 0000 0000 0000 000000.

Veloped0 00 00



B1. 00000 0000 00 0 00 0000 0000 0000 000000. 0 00 4mm 00 0000 0000 0000 000000.

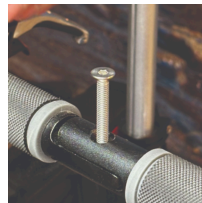

B2. 00 0000 LED 0000 0000 0 0000 0000000. 0 0 00 0000 00000 4mm 00 0000 000000.

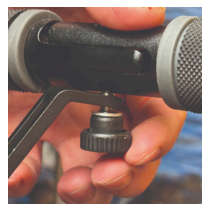

B3. 00 0000 00 00 00 0000 00 0 0000 00 00 0 00000. 0000 000000 0000 0000. 0000 00 0000 000000 0 0000 00 0000 000000.



B4. 0000 00 00000 000000 0000 0000 00 0000 0 0000 00 00000 00 00 0000 00000000 0000000 00 0000 000000 10mm 00000 000000.

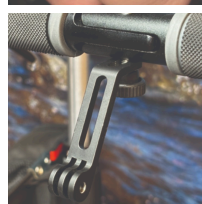

B5. 0 0000 00 0000 000000 0000 0000 00000000.

LED

Veloped



A6. LED light assembly is being attached to the handlebar.



A7. The LED light is now fully mounted and ready for use.

Veloped



B6. The mounting bracket is being secured to the handlebar.



B7. The mounting bracket is now fully secured to the handlebar.

Veloped

Veloped



A8. The strap is being attached to the handlebar.

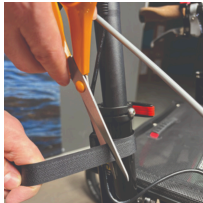

A9. The strap is now fully secured to the handlebar.



A10. The strap is now fully attached and ready for use.

Veloped



B8. The strap is being attached to the handlebar.



B9. The strap is now fully secured to the handlebar.



B10. The strap is now fully attached and ready for use.

LED

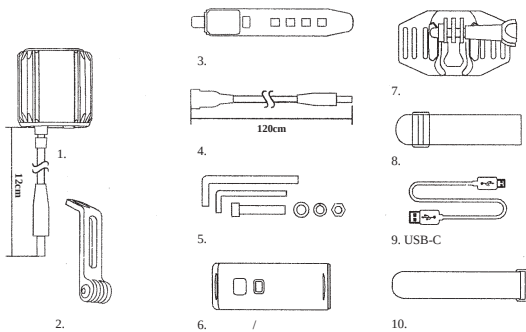

LED

